

Air Oil Coolers

LAC with AC Motor for Industrial Use



ENGINEERING YOUR SUCCESS.

CADE – Cylinder and Accumulator Division Europe

Made in Europe - serving all markets and industries

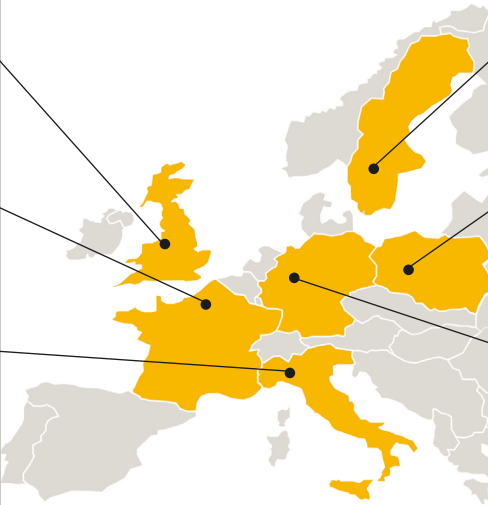

Parker CADE UK
Sandycroft, (Chester)

Parker CADE France
Colombes

Parker CADE Italy
Arsago & Turin

Parker CADE Sweden
Falköping

















Parker CADE Poland
Wroclaw

Parker CADE Germany
Cologne

www.parker/acde



Our product range - click for more detail:

 Bladder Accumulators	 Piston Accumulators	 Diaphragm Accumulators	 Pulsation Dampers	 Attenuators	 Gas Bottles
 Accessories	 Air-Oil Cooler	 Water-Oil Cooler	 QPM Pump	 Industrial Hydraulic Cylinders	 Mill-type Cylinders
 Helical Actuators	 Lightraulics®	 Service Center	 Services & Support	 ENGINEERING YOUR SUCCESS. Fast Track Programme https://discover.parker.com/FastTrackCADE	

Air Oil Cooler Range

As a global player specializing in innovative, efficient system solutions for temperature optimization and energy storage, Parker's products are used for the most diverse environments and applications all over the world.

In hydraulic systems energy is transformed and transmitted. During this process, efficiency losses occur, i.e. mechanical and hydraulic energy is converted into heat. It is the purpose of the cooler to dissipate this heat and to maintain the thermal balance of the hydraulic fluid.

Parker's high performance coolers are equipped with axial fans and IE3 class motors, ensuring your hydraulic system's peak performance.

Click [here](#) or scan QR code Parker's extensive series of air oil coolers for all requirements.

Cooler Range



Why Cooling

Choosing the right cooler requires precise system sizing. The most reliable way to size a cooler is with the aid of our calculation program. This program, together with precise evaluations from our experienced, skilled engineers, gives you the opportunity for more cooling per \$ invested.

Overheating - an expensive problem

An underestimated cooling capacity produces a temperature that is too high. The consequences are poor lubricating properties, higher internal leakage, a higher risk of cavitation, damaged components, etc.

Overheating leads to a significant drop in efficiency which can be detrimental to our environment.

Temperature optimization - a basic prerequisite for cost-efficient operation

Temperature balance in a hydraulic system occurs when the cooler can cool down the energy input that the system does not consume - the system's lost energy.

Temperature optimization occurs at the temperature at which the oil viscosity is maintained at recommended values.



LAC - Air Oil Coolers

For industrial use – maximum cooling capacity 300 kW

The LAC air oil cooler with single-phase or three-phase AC motor is optimized for use in the industrial sector. Together with a wide range of accessories, the LAC cooler is suitable for installation in most applications and environments. The maximum cooling capacity is 300 kW at ETD 40 °C.



Parker's Air Oil cooler range also includes the following versions:

LAC-X (ATEX version) **MAC** (Marine applications).

The LAC-X version is approved for applications where there may be an explosive environment above ground.

The MAC is especially suitable for marine environment to be better able to deal with corrosion attacks.

Please contact your Parker representative for more details!



The Olaer Group has been part of Parker Hannifin since July 1st, 2012. With manufacturing and sales in 14 countries in North America, Asia and Europe, the Olaer Group expands Parker's presence in geographic growth areas and offers expertise in hydraulic accumulator and cooling systems for target growth markets such as oil and gas, power generation and renewable energy.

YOUR VALUE

- Easy to maintain and easy to retrofit in many applications
- Cooler matrix with low pressure drop and high cooling capacity
- Clever design and the right choice of materials and components produce a long useful life
- AC motor single-phase for smaller and three-phase for larger cooler sizes
- Service and repair costs are reduced
- High efficiency level preserved in continuous operation
- Compact design and light weight
- Quiet fan and fan motor
- REACH & RoHS compliant

Calculate the Cooling Capacity Requirement

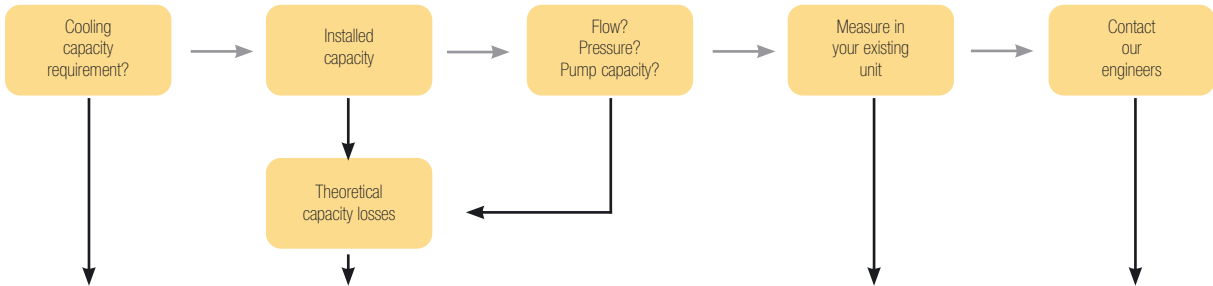

Choose the right kind of cooler

Enter your values

... suggested solution

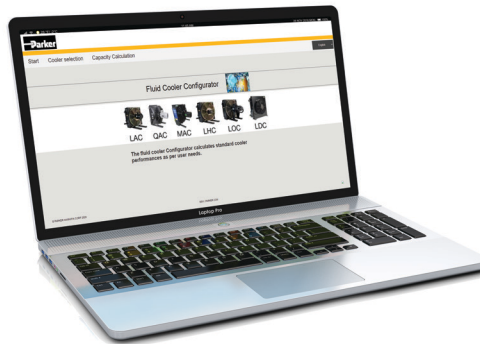

<https://divapps.parker.com/divapps/CADE/SSW/>

LAC2 011-4-D

Date: 2007-09-18
Your reference: Your reference:

Input data:
 ISO VG 46
 Oil flow: 80,0 l/min
 Max. oil temperature: 55 °C
 Air temperature: 25 °C
 Altitude: 0 m
 Heat dissipation: 10,0 kW

Calculated data:
 Inlet oil temperature: 55 °C
 Outlet oil temperature: 55 °C
 Inlet air temperature: 25 °C
 Outlet air temperature: 38 °C
 Spec. heat dissipation: 10,33/9,70 kW/°C
 Oil pressure drop: 0,41 bar
 Air flow: 0,25 m³/s
 Motor capacity: 0,25 kW
 Inlet: 1/2" NPT
 Outlet: 1/2" NPT
 Weight: 28 kg

Technical data:
 Motor capacity: 0,25 kW
 Weight: 28 kg
 Cooling area: 0,11 m²

Female threaded connection.
 A free space corresponding to minimum half the height of the mastic should be available in front of and behind the cooler.

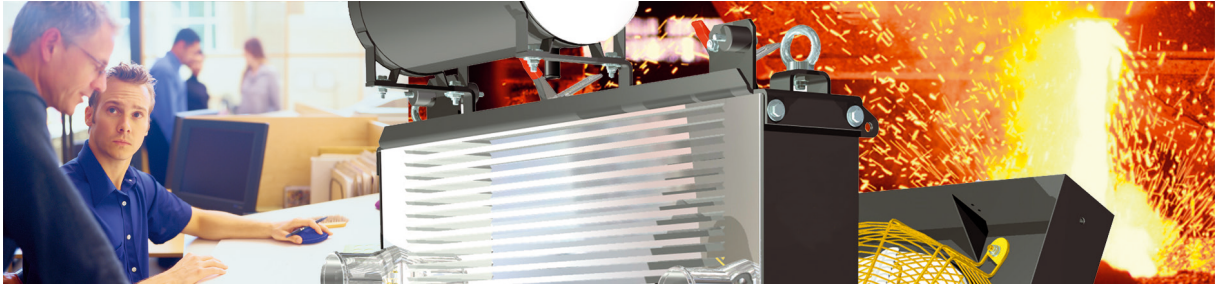

Better energy consumption means not only less environmental impact, but also reduces operating costs, i.e. more cooling per € invested.

More Cooling per € with precise calculations and our engineers' support

Optimal sizing produces efficient cooling. Correct sizing requires knowledge and experience. Our calculation program, combined with our engineers' support, gives you access to this very knowledge and experience.

The result is more cooling per € invested. The user-friendly calculation program can be downloaded from www.parker.com/acde.

Valuable system review into the bargain

A more wide-ranging review of the hydraulic system is often a natural element of cooling calculations. Other potential system improvements can then be discussed – e.g. filtering, offline or online cooling, etc. Contact us for further guidance and information.

Parker Hannifin's quality and performance guarantee insurance for your operations and systems

A constant striving towards more cost-efficient and environment friendly hydraulic systems requires continuous development. Areas where we are continuously seeking to improve performance include cooling capacity, noise level, pressure drop and fatigue.

Meticulous quality and performance tests are conducted in our laboratory. All tests and measurements take place in accordance with standardised methods - cooling capacity in accordance with EN1048, noise level ISO 3743, pressure drop EN 1048 and fatigue ISO 10771-1.

**NEW
COOLER SIZING APP**

No download needed - **live sizing software:**



The cooling capacity curves are based on the inlet oil temperature and the ambient air temperature. An oil temperature of 60 °C and an air temperature of 20 °C produce a temperature difference of 40 °C. Multiply by kW/°C for total cooling capacity.

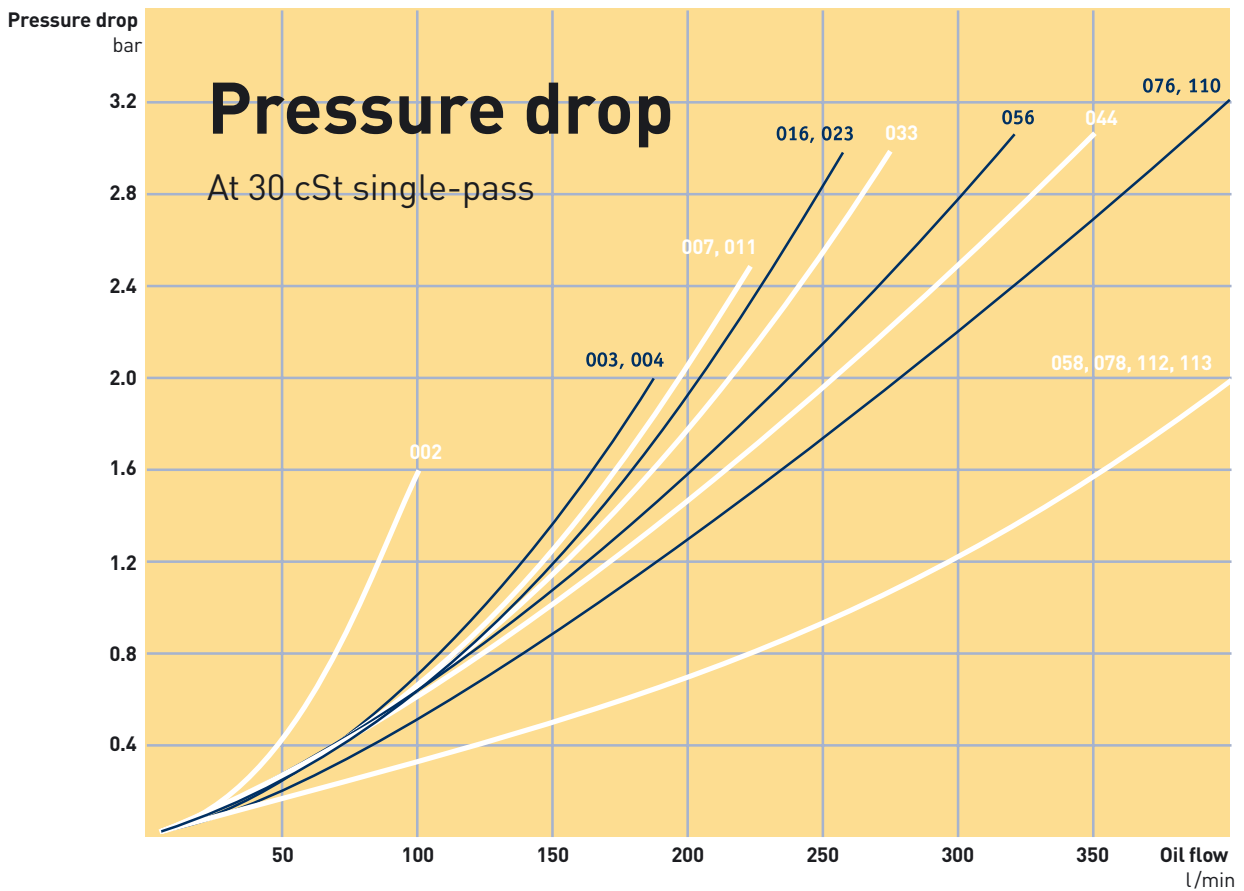

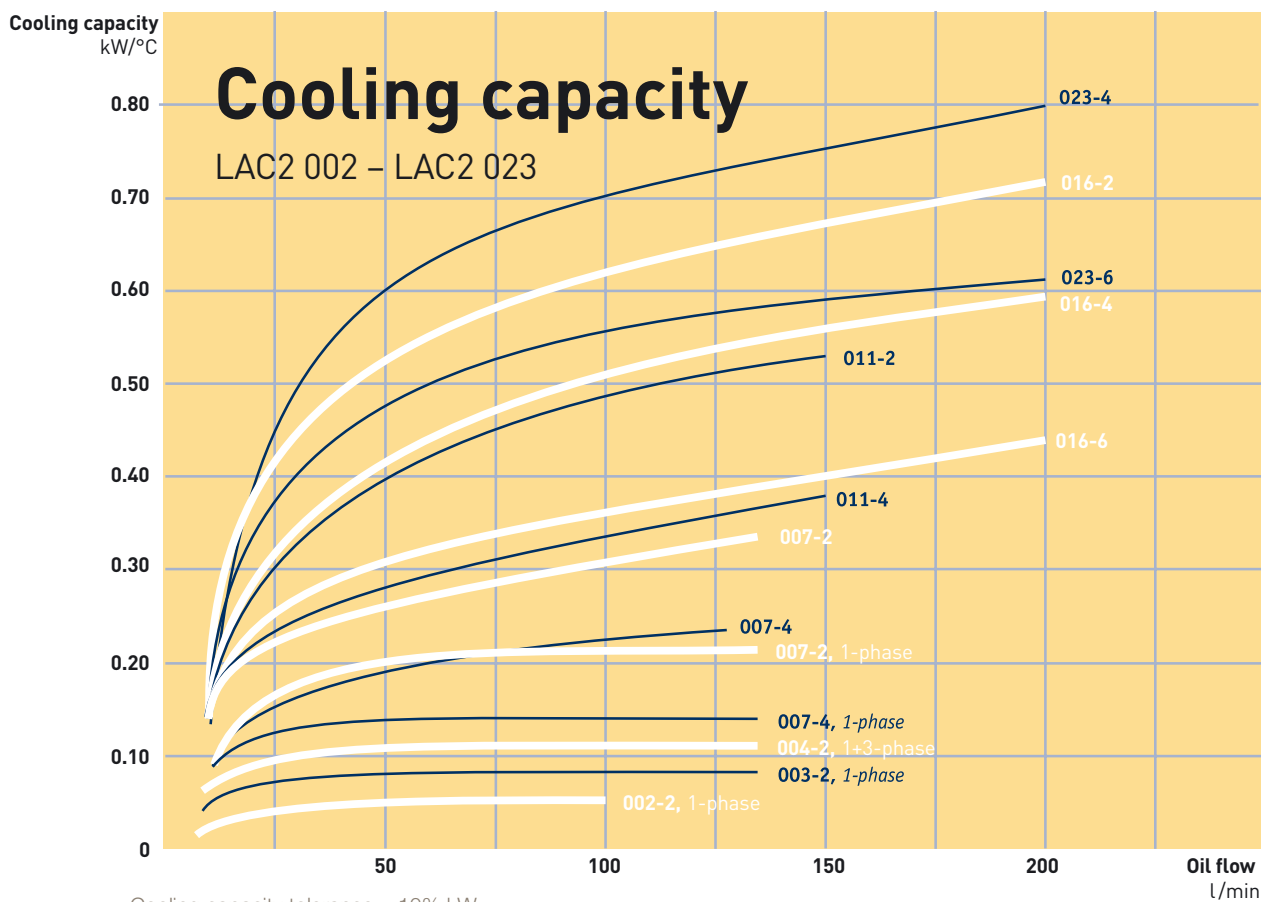
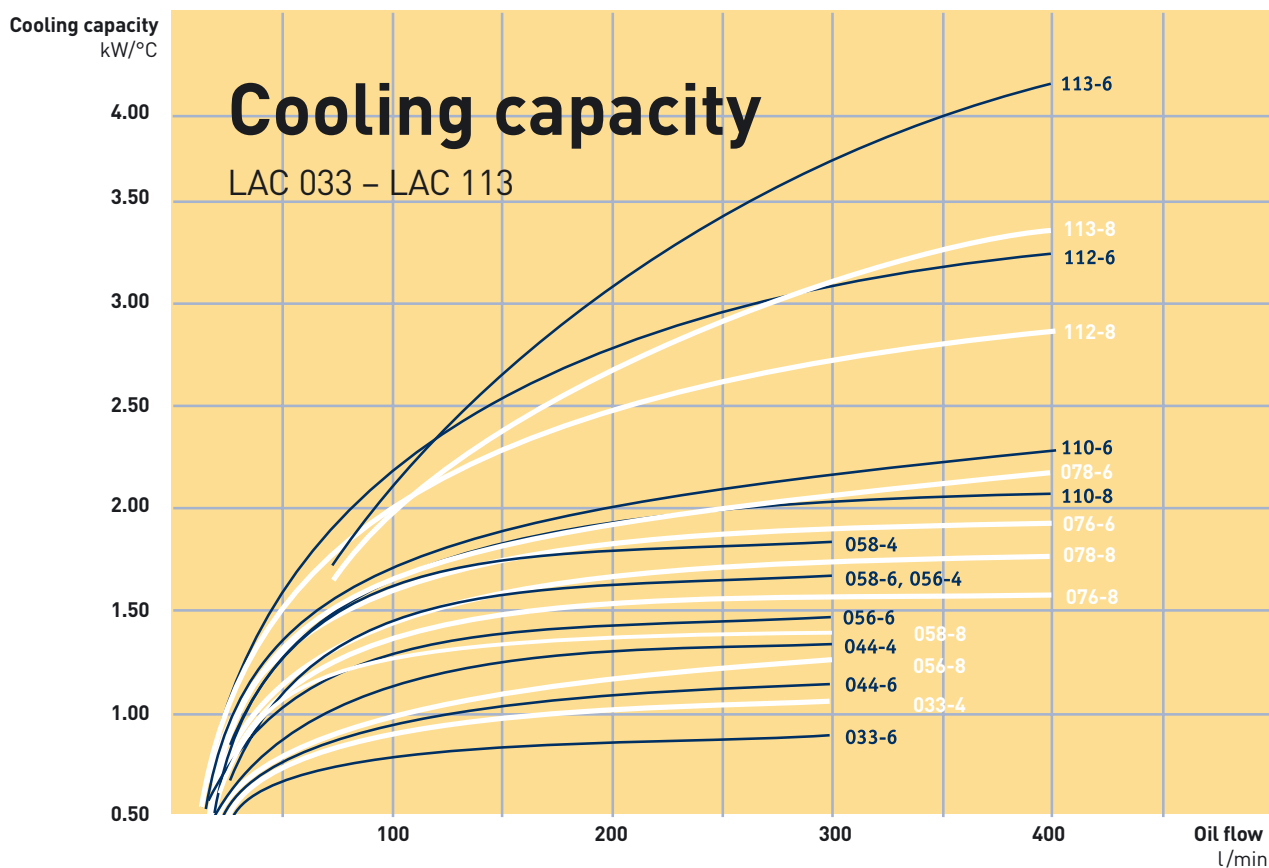

Cooling capacity tolerance $\pm 10\%$ kW.

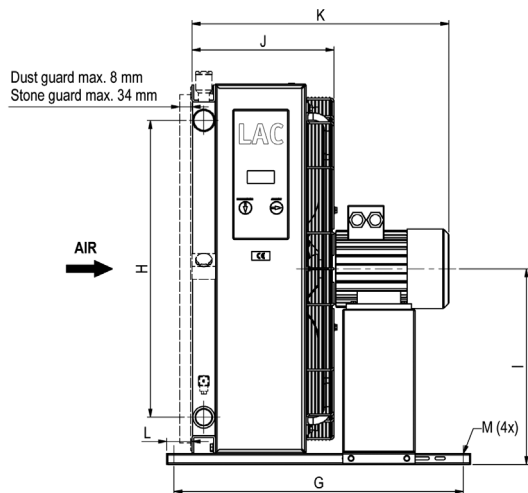

TYPE	Acoustic pressure level LpA dB(A) 1m*	No. of poles/ Capacity kW	Weight kg (approx)
LAC2 002-2-single-phase	50	2-0.05	4
LAC2 003-2-single-phase	61	2-0.05	5
LAC2 004-2-single-phase	63	2-0.07	6
LAC2 004-2-single-phase	63	2-0.07	6
LAC2 007-4-single-phase	65	2-0.08	9
LAC2 007-2-single-phase	79	2-0.24	10
LAC2 007-4-three-phase	62	4-0.25	15
LAC2 007-2-three-phase	79	2-0.55	16
LAC2 011-4-three-phase	67	4-0.25	20
LAC2 011-2-three-phase	82	2-1.10	25
LAC2 016-6-three-phase	60	6-0.18	23
LAC2 016-4-three-phase	70	4-0.37	24
LAC2 016-2-three-phase	86	2-1.10	27
LAC2 023-6-three-phase	64	6-0.18	35
LAC2 023-4-three-phase	76	4-0.75	36
LAC 033-6-three-phase	74	6-0.55	45
LAC 033-4-three-phase	84	4-2.20	52
LAC 044-6-three-phase	76	6-0.55	63
LAC 044-4-three-phase	85	4-2.20	65
LAC 056-8-three-phase	73	8-0.75	73
LAC 056-6-three-phase	81	6-1.50	75
LAC 056-4-three-phase	84	4-3.0	75
LAC 058-8-three-phase	74	8-0.75	80
LAC 058-6-three-phase	82	6-1.50	82
LAC 058-4-three-phase	85	4-3.0	82
LAC 076-8-three-phase	79	8-1.10	130
LAC 076-6-three-phase	86	6-2.20	140
LAC 078-8-three-phase	80	8-1.10	136
LAC 078-6-three-phase	87	6-2.20	146
LAC 110-8-three-phase	84	8-2.20	160
LAC 110-6-three-phase	90	6-5.50	170
LAC 112-8-three-phase	85	8-2.20	168
LAC 112-6-three-phase	91	6-5.50	178
LAC 113-8-three-phase	80	8-2.20	218
LAC 113-6-three-phase	88	6-5.50	237

* = Noise level tolerance ± 3 dB(A).

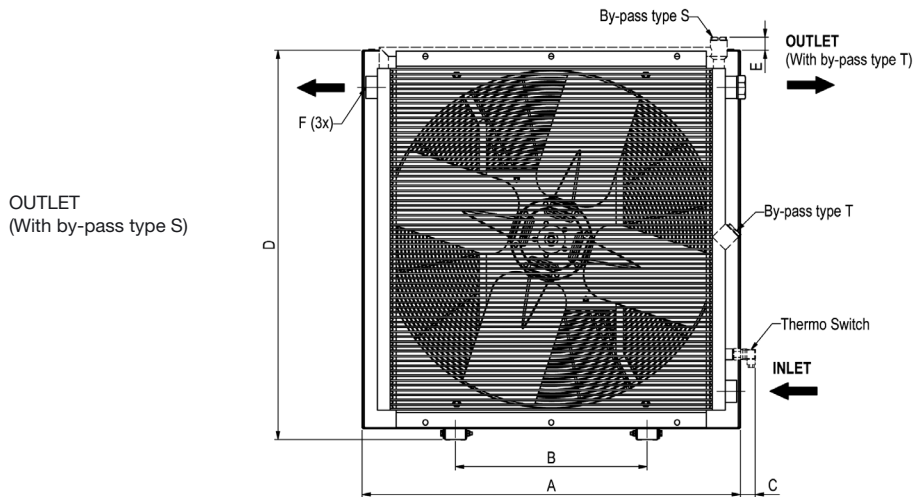

TYPE	A	B	C	D	E	F	G	H	I	J	K	L	Mø
LAC2 002-2-single-phase	165	74	82	189	-	G1/2	190	72	97	105	167	39	9
LAC2 003-2-single-phase	244	134	82	223	71	G1	148	90	114	161	218	31	9x14
LAC2 004-4-single-phase	267	134	82	256	69	G1	148	90	131	165	222	28	9x14
LAC2 004-2-single-phase	267	134	82	256	69	G1	148	90	131	165	222	28	9x14
LAC2 007-4-single-phase	340	203	77	345	54	G1	267	160	175	189	249	49	9x14
LAC2 007-2-single-phase	340	203	77	345	54	G1	267	160	175	189	249	49	9x14
LAC2 007-4-three-phase	365	203	64	395	42	G1	510	160	213	225	429	50	9
LAC2 007-2-three-phase	365	203	64	395	42	G1	510	160	213	225	434	50	9
LAC2 011-4-three-phase	440	203	62	470	41	G1	510	230	250	249	453	50	9
LAC2 011-2-three-phase	440	203	62	470	41	G1	510	230	250	249	475	50	9
LAC2 016-6-three-phase	496	203	66	526	46	G1	510	230	278	272	474	50	9
LAC2 016-4-three-phase	496	203	66	526	46	G1	510	230	278	272	479	50	9
LAC2 016-2-three-phase	496	203	66	526	46	G1	510	230	278	272	496	50	9
LAC2 023-6-three-phase	580	356	63	610	44	G1	510	305	320	287	489	50	9
LAC2 023-4-three-phase	580	356	63	610	44	G1	510	305	320	287	511	50	9
LAC 033-6-three-phase	692	356	53	722	42	G1 1/4	510	406	376	318	534	50	9
LAC 033-4-three-phase	692	356	53	722	42	G1 1/4	510	406	376	318	618	50	9
LAC 044-6-three-phase	692	356	53	866	59	G1 1/4	510	584	448	343	559	50	9
LAC 044-4-three-phase	692	356	53	866	59	G1 1/4	510	584	448	343	643	50	9
LAC 056-8-three-phase	868	356	49	898	43	G1 1/4	510	584	448	343	643	50	9
LAC 056-6-three-phase	868	508	49	898	43	G1 1/4	510	584	464	368	668	50	9
LAC 056-4-three-phase	868	508	49	898	43	G1 1/4	510	584	464	368	668	50	9
LAC 058-8-three-phase	868	508	49	898	43	G2	510	584	464	388	652	30	9
LAC 058-6-three-phase	868	508	49	898	43	G2	510	584	464	388	682	30	9
LAC 058-4-three-phase	868	508	49	898	43	G2	510	584	464	388	688	30	9
LAC 076-8-three-phase	1022	518	41	1052	45	G1 1/2	800	821	541	393	693	70	14
LAC 076-6-three-phase	1022	518	41	1052	45	G1 1/2	800	821	541	393	710	70	14
LAC 078-8-three-phase	1022	518	41	1052	45	G2	800	821	541	413	713	50	14
LAC 078-6-three-phase	1022	518	41	1052	45	G2	800	821	541	413	730	50	14
LAC 110-8-three-phase	1185	600	54	1215	45	G2	800	985	623	418	785	70	14
LAC 110-6-three-phase	1185	600	54	1215	45	G2	800	985	623	418	785	70	14
LAC 112-8-three-phase	1185	600	54	1215	45	G2	800	985	623	438	805	50	14
LAC 112-6-three-phase	1185	600	54	1215	45	G2	800	985	623	438	805	50	14
LAC 113-8-three-phase	1200	600	82	1215	45	G2	860	985	623	465	833	82	14
LAC 113-6-three-phase	1200	600	82	1215	45	G2	860	985	623	465	871	82	14



Type	Acoustics pressure level Lp ^A dB(A) 1m*	No. of poles/ Capacity kW	Weight kg (approx)
LAC 200-6	92	6-11.0	405
LAC 200-8	86	8-4.0	365

* = Noise level tolerance ± 3 dB(A)

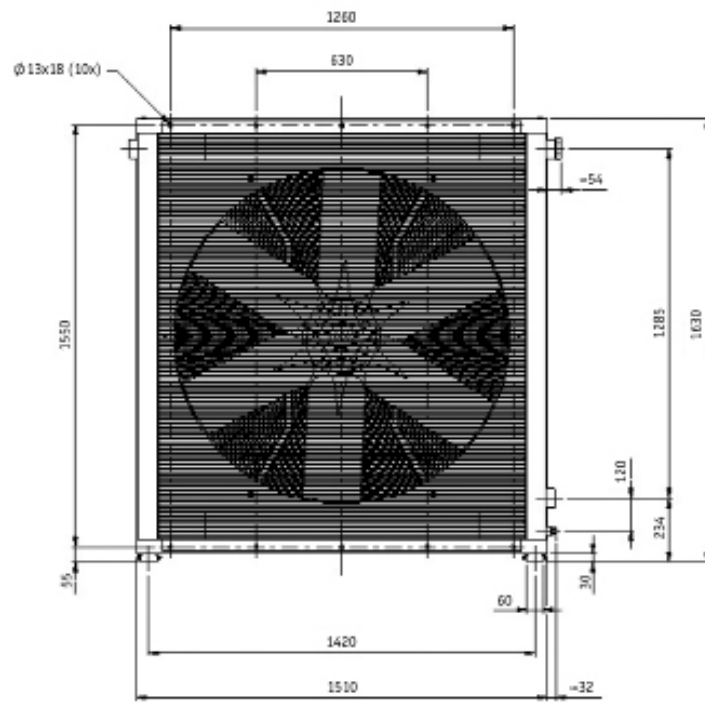
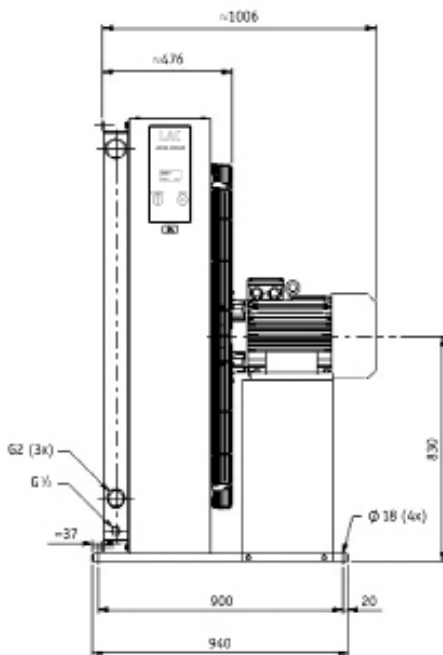

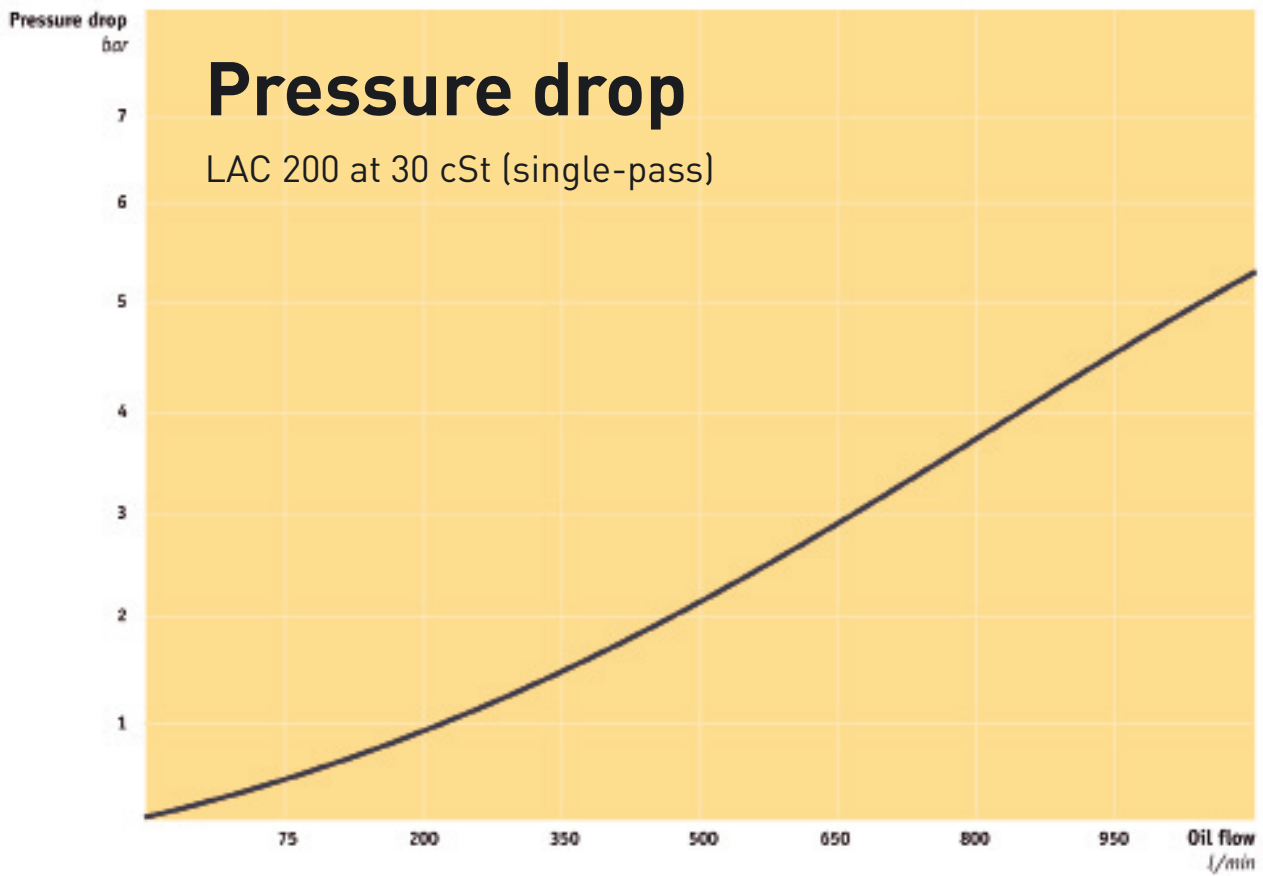
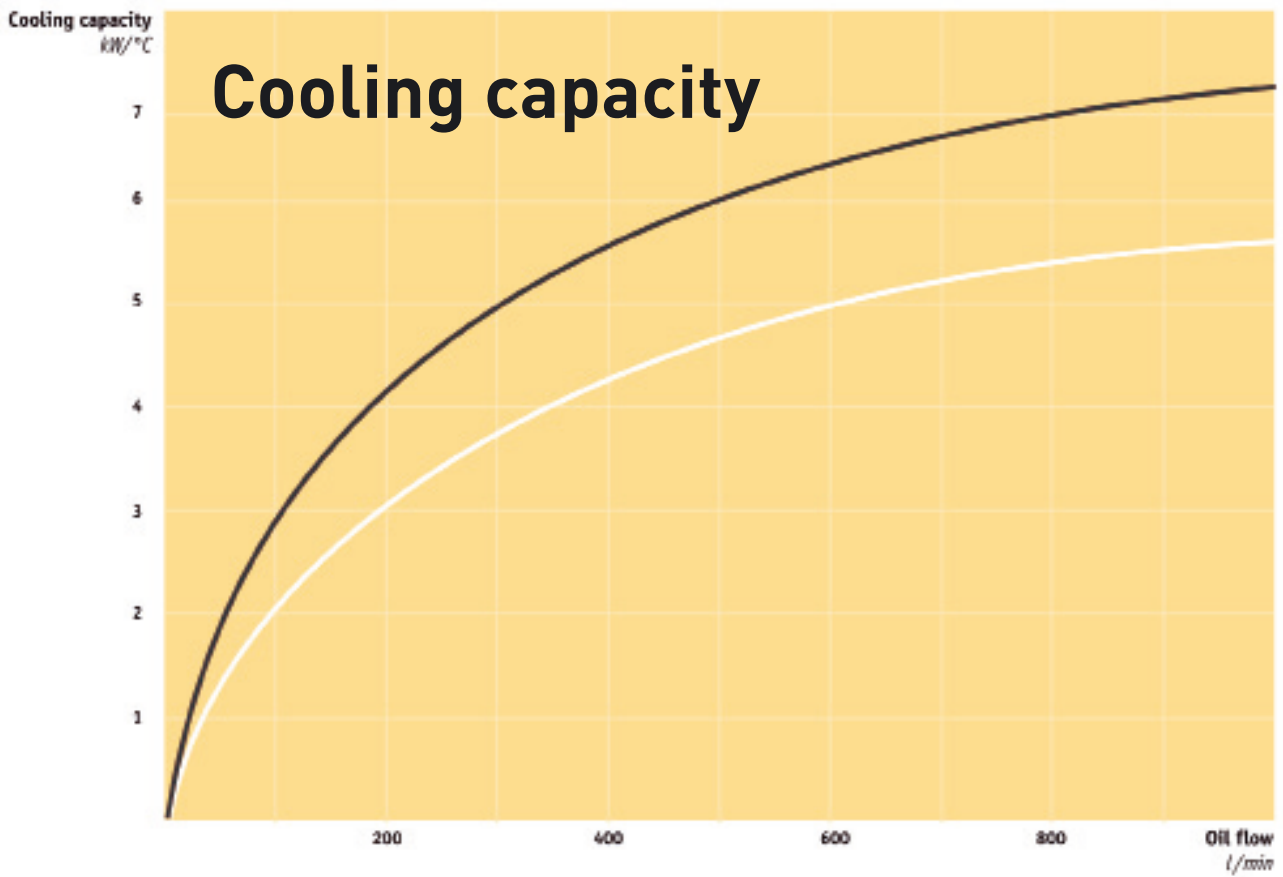

Code Key

LAC	056	4	D	40	T20	D	O
1	2	3	4	5	6	7	8

1	Type	LAC, LAC2
2	Cooler Size	004, 007, 011, 016, 023, 033, 044, 056, 058, 078, 112, 113, 200
3	Number of Poles / Motor	2, 4, 6, 8
4	Voltage and Frequency	0: no motor, A: 230/400V 50Hz, B: 460V alt 480V 60Hz, C: Single Phase 230V 50Hz (not IE2), D:230/400V 50Hz 460 alt, 480 V 60 Hz, E: 500V 50Hz (not standard), F: 400/690V 50Hz 460 alt 480V 60Hz, G: 525V 50Hz, 575V 60Hz, 575V 60Hz, X: Motor for special voltage or frequency (stated in plain language)
5	Thermo Contact	00: no contact 40: 40°C 50: 50°C 60: 60°C 70: 70°C 80: 80°C 90: 90°C
6	Cooler Matrix	000: Standard, T00: Two-pass Built in, pressure-controlled bypass, single pass S20: 2 bar S50: 5 bar S80: 8 bar Built-in, pressure-controlled bypass, two-pass T20: 2 bar T50: 5 bar T80: 8 bar, Built-in temperature and pressure-controlled bypass, single-pass S25: 50°C, 2.2 bar S26: 60°C, 2.2 bar S27: 70°C, 2.2 bar S29: 90°C, 2.2 bar Built-in temperature and pressure-controlled bypass, two-pass T25: 50°C, 2.2. bar T26: 60°C, 2.2. bar T27: 70°C, 2.2. bar T29: 90°C, 2.2 bar
7	Matrix Guard	0: no guard, S: stone guard, D: dust guard, P: dust and stone guard
8	Standard / Special	O: standard, Z: special



Configure your product on parker.com

Technical Specifications

Fluid Combinations

Mineral Oil	HL/HLP in accordance with DIN 515
Oil / water emulsion	HFA, HFB in accordance with CETOP RP 77H
Water glycol	HFC in accordance with CETOP RP 77H
Phosphate ester	HFD-R in accordance with CETOP RP 77H

Material

Cooler matrix	Aluminium
Fan blades / hub	Glass fibre reinforced polypropylene / Aluminium
Fan housing	Steel
Fan guard	Steel
Other parts	Steel
Surface treatment	Electrostatically powder-coated

Technical Data, Cooler Matrix

Maximum static operating pressure	21 bar
Dynamic operating pressure	14 bar
Heat transfer limit	+/- 6%
Maximum oil inlet temperature	120°C

Technical Data for 3-Phase Motor

3-phase asynchronous motors in accordance with IEC 34-1 and IEC 72 in accordance with DIN 67530/VDE 0530

Insulation class	F
Rise of temperature	B
Protection class	IP 55

Technical Data for 1-Phase Motor

Insulation class	B
Rise of temperature	B
Protection class	IP 44

Technical Data for 3-Phase Motor LAC2 004

Rated voltage	230 / 400 V - 50 / 60 Hz
Insulation class	B
Rise of temperature	B
Protection class	IP 44

Cooling Capacity Curve

The cooling capacity curves in this technical data sheet are based on tests in accordance with EN 1048 and have been produced in oil type ISO VG 46 at 60°C.

Contact Parker Hannifin for Advice on

Oil temperatures > 120°C / Oil viscosity > 100 cSt

Take the Next Step

- choose the right accessories

With our specialist expertise, industry knowledge and advanced technology, we can offer a range of different solutions for coolers and accessories to meet your requirements.

Supplementing a hydraulic system with a cooler, cooler accessories and an accumulator gives you increased availability and a longer useful life, as well as lower service and repair costs.

All applications and operating environments are unique. A well-planned choice of the following accessories can thus further improve your hydraulic system.

Please contact Parker Hannifin for guidance and information.

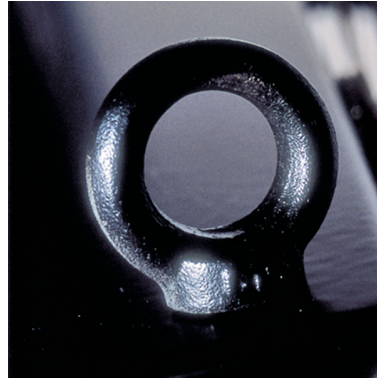

Lifting eyes - included as standard
For safe and simple handling during installation and relocation - only used for installation and maintenance

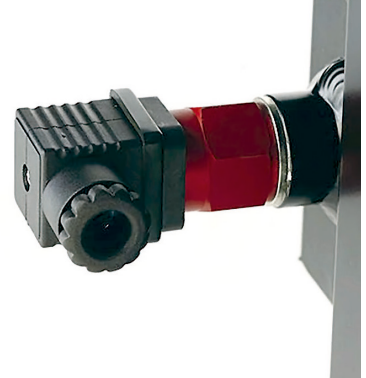

Thermo contact
Sensor with fixed set point, for temperature warnings. Can be used for more cost-efficient operation and better environmental consideration through the automatic control of the fan motor, either on or off.

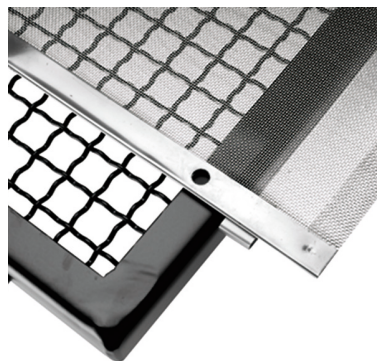
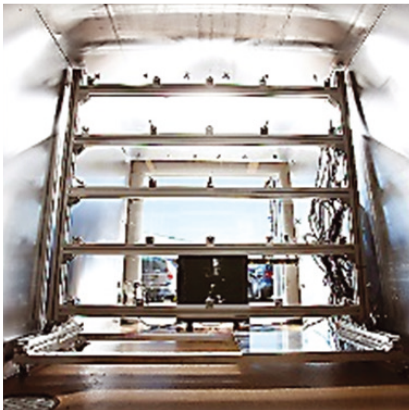

Stone guard/Dust guard
In dirty environments a dust guard prevents the matrix from getting clogged by medium and large size particles or chips and allows easier maintenance. The Stone guard protects the matrix from damage by projectiles. When shielded, the cooler is protected in the toughest conditions and the risk of unscheduled maintenance is reduced to a minimum.



Temperature-controlled bypass valve Integrated
Allows the oil to bypass the cooler matrix if the pressure drop is higher than 2,2 bar or less than the chosen temperature. The bypass closes when the oil temperature increases. Different closing temperatures available. Available for singlepass or two-pass matrix design



Check out Parker's Fast Track Programme

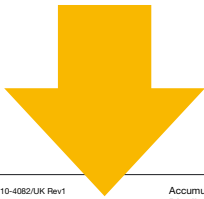

includes many options for LAC coolers

Catalogue MSG10-4082/UK Rev1 Accumulators and Coolers Distributor Catalogue

Air Oil Cooler with AC Motor - LAC Series

Suitable for most industrial applications, the LAC air oil cooler series offers an efficient and robust design and is available in a range of cooling capacities from 1 kW to 300 kW.

Part Number	TYPE	Dimensions (mm)												
		A	B	C	D	E	F	G	H	I	J	K	L	Ma
LAC2-004C0000000000000000	LAC2-004-3-D-00-0000-0-0	207	134	82	256	59	51	148	90	131	155	222	28	361.4
LAC2-004C0000000000000000	LAC2-004-3-D-00-0000-0-0	207	134	82	256	59	51	148	90	131	155	222	28	361.4
LAC2-007C0000000000000000	LAC2-007-4-D-00-0000-0-0	308	202	94	285	82	51	170	100	143	200	129	36	458
LAC2-007C0000000000000000	LAC2-007-4-D-00-0000-0-0	308	202	94	285	82	51	170	100	143	200	129	36	458
LAC2-011C0000000000000000	LAC2-011-4-D-00-0000-0-0	340	203	82	470	81	51	170	220	220	249	403	30	518
LAC2-011C0000000000000000	LAC2-011-4-D-00-0000-0-0	340	203	82	470	81	51	170	220	220	249	403	30	518
LAC2-016C0000000000000000	LAC2-016-4-D-00-0000-0-0	436	203	66	526	86	51	170	220	278	272	479	30	578
LAC2-016C0000000000000000	LAC2-016-4-D-00-0000-0-0	436	203	66	526	86	51	170	220	278	272	479	30	578
LAC2-016C0000000000000000	LAC2-016-4-D-00-0000-0-0	436	203	66	526	86	51	170	220	278	272	479	30	578
LAC2-023C0000000000000000	LAC2-023-4-D-00-0000-0-0	500	206	83	610	84	51	170	220	320	287	511	30	618
LAC2-023C0000000000000000	LAC2-023-4-D-00-0000-0-0	500	206	83	610	84	51	170	220	320	287	511	30	618
LAC2-023C0000000000000000	LAC2-023-4-D-00-0000-0-0	500	206	83	610	84	51	170	220	320	287	511	30	618
LAC2-032C0000000000000000	LAC2-032-4-A-00-0000-0-0	592	306	133	722	122	51	170	310	428	378	618	30	718
LAC2-032C0000000000000000	LAC2-032-4-A-00-0000-0-0	592	306	133	722	122	51	170	310	428	378	618	30	718
LAC2-044C0000000000000000	LAC2-044-4-A-00-0000-0-0	692	306	133	808	129	51	170	310	504	448	643	30	818
LAC2-044C0000000000000000	LAC2-044-4-A-00-0000-0-0	692	306	133	808	129	51	170	310	504	448	643	30	818
LAC2-044C0000000000000000	LAC2-044-4-A-00-0000-0-0	692	306	133	808	129	51	170	310	504	448	643	30	818
LAC2-058C0000000000000000	LAC2-058-4-A-00-0000-0-0	808	308	49	898	143	52	170	384	464	538	698	30	918
LAC2-058C0000000000000000	LAC2-058-4-A-00-0000-0-0	808	308	49	898	143	52	170	384	464	538	698	30	918

PRODUCT BENEFITS

- ⇒ For industrial applications
- ⇒ Cooling capacity up to 300 kW
- ⇒ Robust construction
- ⇒ Low service and maintenance
- ⇒ Wide variety of specifications

For the complete product range see: www.parker.com

<https://discover.parker.com/FastTrackCADE>

⚠ WARNING – USER RESPONSIBILITY

FAILURE OR IMPROPER SELECTION OR IMPROPER USE OF THE PRODUCTS DESCRIBED HEREIN OR RELATED ITEMS CAN CAUSE DEATH, PERSONAL INJURY AND PROPERTY DAMAGE.

This document and other information from Parker-Hannifin Corporation, its subsidiaries and authorized distributors provide product or system options for further investigation by users having technical expertise.

The user, through its own analysis and testing, is solely responsible for making the final selection of the system and components and assuring that all performance, endurance, maintenance, safety and warning requirements of the application are met. The user must analyze all aspects of the application, follow applicable industry standards, and follow the information concerning the product in the current product catalog and in any other materials provided from Parker or its subsidiaries or authorized distributors.

To the extent that Parker or its subsidiaries or authorized distributors provide component or system options based upon data or specifications provided by the user, the user is responsible for determining that such data and specifications are suitable and sufficient for all applications and reasonably foreseeable uses of the components or systems.

Offer of Sale

Please contact your Parker representation for a detailed 'Offer of Sale'.

Parker Worldwide

Europe, Middle East, Africa

AE – United Arab Emirates,
Dubai
Tel: +971 4 8127100

AT – Austria, St. Florian
Tel: +43 (0)7224 66201

AZ – Azerbaijan, Baku
Tel: +994 50 2233 458

BE/NL/LU – Benelux,
Hendrik Ido Ambacht
Tel: +31 (0)541 585 000

BY – Belarus, Minsk
Tel: +48 (0)22 573 24 00

CH – Switzerland, Etoy
Tel: +41 (0)21 821 87 00

CZ – Czech Republic,
Prague
Tel: +420 284 083 111

DE – Germany, Kaarst
Tel: +49 (0)2131 4016 0

DK – Denmark, Ballerup
Tel: +45 43 56 04 00

ES – Spain, Madrid
Tel: +34 902 330 001

FI – Finland, Vantaa
Tel: +358 (0)20 753 2500

FR – France, Contamine s/Arve
Tel: +33 (0)4 50 25 80 25

GR – Greece
Tel: +30 69 44 52 78 25

HU – Hungary, Budaörs
Tel: +36 23 885 470

IE – Ireland, Dublin
Tel: +353 (0)1 466 6370

IL – Israel
Tel: +39 02 45 19 21

IT – Italy, Corsico (MI)
Tel: +39 02 45 19 21

KZ – Kazakhstan, Almaty
Tel: +7 7273 561 000

NO – Norway, Asker
Tel: +47 66 75 34 00

PL – Poland, Warsaw
Tel: +48 (0)22 573 24 00

PT – Portugal
Tel: +351 22 999 7360

RO – Romania, Bucharest
Tel: +40 21 252 1382

RU – Russia, Moscow
Tel: +7 495 645-2156

SE – Sweden, Borås
Tel: +46 (0)8 59 79 50 00

SL – Slovenia, Novo Mesto
Tel: +386 7 337 6650

TR – Turkey, Istanbul
Tel: +90 216 4997081

UK – United Kingdom, Warwick
Tel: +44 (0)1926 317 878

ZA – South Africa, Kempton Park
Tel: +27 (0)11 961 0700

North America

CA – Canada, Milton, Ontario
Tel: +1 905 693 3000

US – USA, Cleveland
Tel: +1 216 896 3000

Asia Pacific

AU – Australia, Castle Hill
Tel: +61 (0)2-9634 7777

CN – China, Shanghai
Tel: +86 21 2899 5000

HK – Hong Kong
Tel: +852 2428 8008

IN – India, Mumbai
Tel: +91 22 6513 7081-85

JP – Japan, Tokyo
Tel: +81 (0)3 6408 3901

KR – South Korea, Seoul
Tel: +82 2 559 0400

MY – Malaysia, Shah Alam
Tel: +60 3 7849 0800

NZ – New Zealand, Mt Wellington
Tel: +64 9 574 1744

SG – Singapore
Tel: +65 6887 6300

TH – Thailand, Bangkok
Tel: +662 186 7000

TW – Taiwan, Taipei
Tel: +886 2 2298 8987

South America

AR – Argentina, Buenos Aires
Tel: +54 3327 44 4129

BR – Brazil, Sao Jose dos Campos
Tel: +55 080 0727 5374

CL – Chile, Santiago
Tel: +56 22 303 9640

MX – Mexico, Toluca
Tel: +52 72 2275 4200

